

# Data Sheet



Article number: 021500700055

Description: Sealing Clamp S 55 W5

## Measures

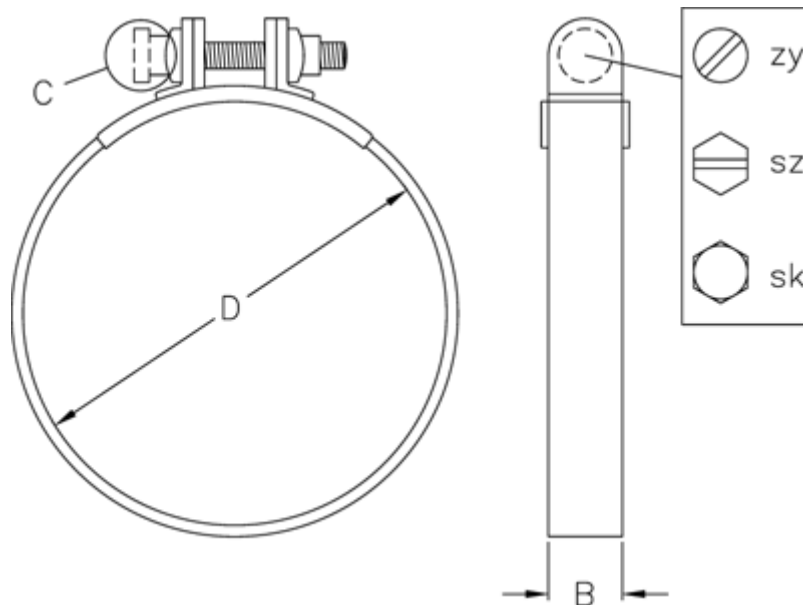

C (screw type) = SZ

Diameter D = 55

Width B = 20